

CHECKPOINT

THERAPEUTICS

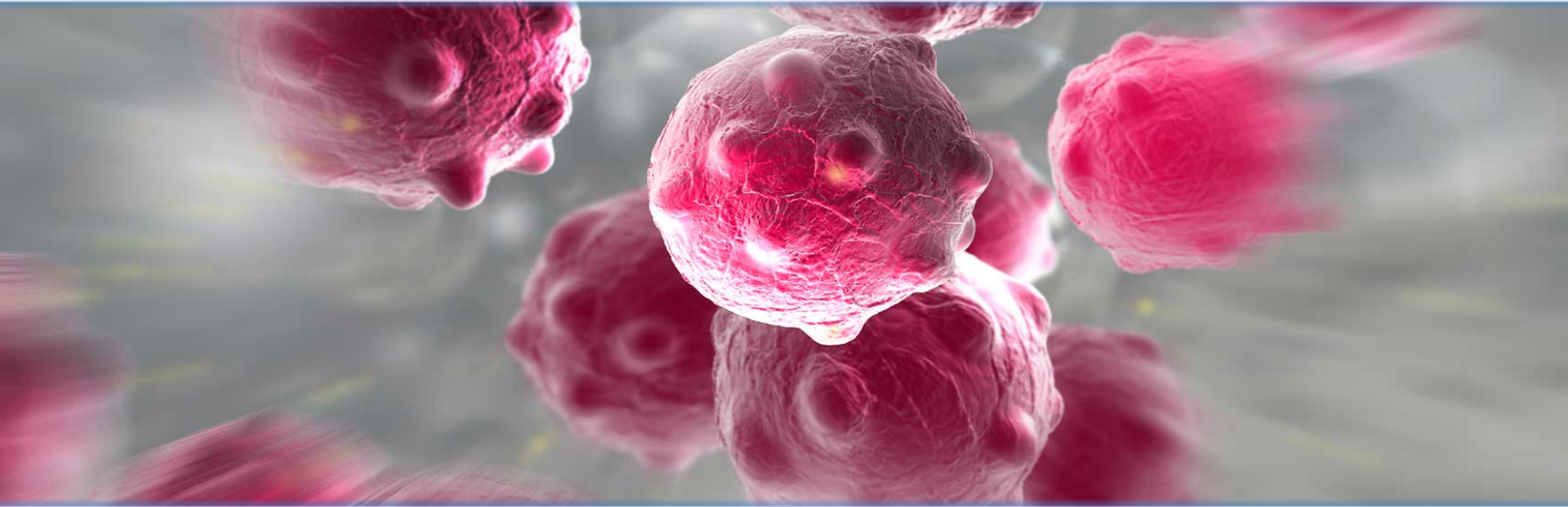

NASDAQ: CKPT
CORPORATE PRESENTATION

July 2019

A microscopic view of several cells, likely cancer cells, with a purple and pink color scheme. The cells are irregular in shape and have a textured surface. They are set against a background of a purple and pink gradient with a bokeh effect. The cells are reflected on a white surface below them.

FORWARD LOOKING SAFE HARBOR STATEMENT

This presentation contains forward-looking statements within the meaning of the Private Securities Litigation Reform Act of 1995. These statements are often, but not always, made through the use of words or phrases such as “anticipates”, “expects”, “plans”, “believes”, “intends”, and similar words or phrases. Such statements involve risks and uncertainties that could cause Checkpoint Therapeutics’ actual results to differ materially from the anticipated results and expectations expressed in these forward-looking statements. These statements are only predictions based on current information and expectations and involve a number of risks and uncertainties. Actual events or results may differ materially from those projected in any such statements due to various factors, including the risks and uncertainties inherent in clinical trials, drug development, and commercialization. You should carefully read the Special Cautionary Notice Regarding Forward-Looking Statements and the Risk Factors sections of Checkpoint Therapeutics’ public filings with the Securities and Exchange Commission (SEC) to better understand the risks and inherent uncertainties in its business. You are cautioned not to place undue reliance on these forward-looking statements, which speak only as of the date hereof. All forward-looking statements are qualified in their entirety by this cautionary statement and Checkpoint Therapeutics undertakes no obligation to update these statements, except as required by law.

ONCOLOGY PRODUCT PORTFOLIO

SOLID TUMOR FOCUS



Portfolio of Targeted and Immuno-Oncology Agents

CK-101

3rd Generation EGFR Inhibitor

Registration trial expected to commence YE 2019
1st line EGFR mutation-positive NSCLC

Cosibelimab (CK-301)

anti-PD-L1 mAb

Phase 1 registration-enabling expansion cohorts ongoing
Potential to support one or more BLA filings

CK-103

BET Inhibitor

IND pending submission

CK-302

anti-GITR mAb

IND-enabling studies ongoing

CK-303

anti-CAIX mAb

IND-enabling studies pending

Targeted anti-cancer agents

Immuno-oncology agents

EGFR MUTATION-POSITIVE NSCLC

WELL-VALIDATED TARGET



- 1st and 2nd generation EGFR inhibitors lead to acquired resistance to therapy, mainly due to T790M resistance mutation
- 3rd generation EGFR inhibitors target EGFR activating mutations and T790M resistance mutation leading to longer responses
 - Tagrisso[®] (osimertinib) is only marketed 3rd gen inhibitor with a projected market opportunity >\$6 billion annually
 - Warnings and precautions: QTc prolongation (4.5%), interstitial lung disease (3.9%), cardiomyopathy (2.6%)
 - Ph 3 (FLAURA) study AEs: diarrhea (58%), rash (58%), dry skin (36%), nail toxicity (35%), stomatitis (29%)
 - 13% of patients permanently discontinued due to AEs

CK-101: PHASE 1 INTERIM DATA

STUDY DESIGN



Dose Escalation Cohorts
All Solid Tumors
(N=18)

1st Expansion Cohort: 400 mg bid
NSCLC Target Population
(N=19)

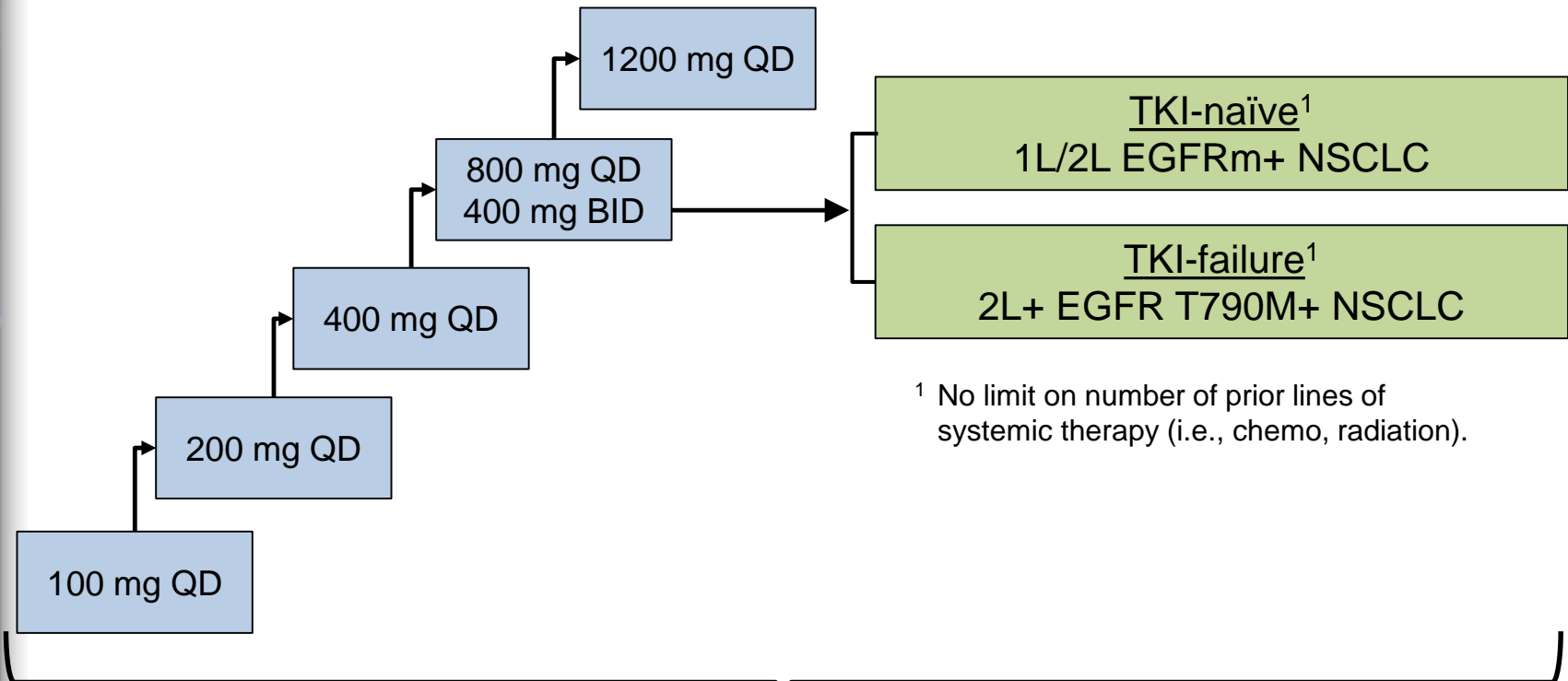

¹ No limit on number of prior lines of systemic therapy (i.e., chemo, radiation).

Oral Presentation World Conference on Lung Cancer (WCLC)
Sept 2018

CK-101: PHASE 1 INTERIM DATA

EMERGING SAFETY DIFFERENTIATION



- CK-101 was well-tolerated
 - Most adverse events were Grade 1-2
 - No DLTs or treatment-related SAEs

- **No events of:**
 - Interstitial lung disease (ILD)
 - Pneumonitis
 - QTc prolongation
 - Cardiomyopathy
 - Nail toxicities
 - Stomatitis
 - Hyperglycemia

Most Common (≥ 3 pts) Treatment-Related Adverse Events, n (%)	CK-101 All Patients Treated (N=37)		
	All Grades	Grade 3	Grade 4
Nausea	6 (16%)	-	-
Diarrhea	5 (14%)	1 (3%)	-
Lacrimation incr.	5 (14%)	-	-
Vomiting	4 (11%)	-	-
Bilirubin incr.	3 (8%)	2 (5%)	-
Rash	3 (8%)	2 (5%)	-
ALT incr.	3 (8%)	1 (3%)	-
AST incr.	3 (8%)	1 (3%)	-
Pruritus	3 (8%)	1 (3%)	-
Dysphonia	3 (8%)	-	-
Hypoesthesia	3 (8%)	-	-

Oral Presentation: World Lung Sept 2018

CK-101: PHASE 1 INTERIM DATA

EFFICACY IN EGFRM+ NSCLC



- Confirmed ORR: 53% (10/19)
 - 75% (6/8) treatment-naïve pts achieved partial response
 - Phase 3 target population
 - 84% (16/19) pts had target lesion reductions versus baseline
 - 100% (19/19) DCR

- 60% (3/5) pts with brain metastases at baseline achieved partial response with intracranial reductions

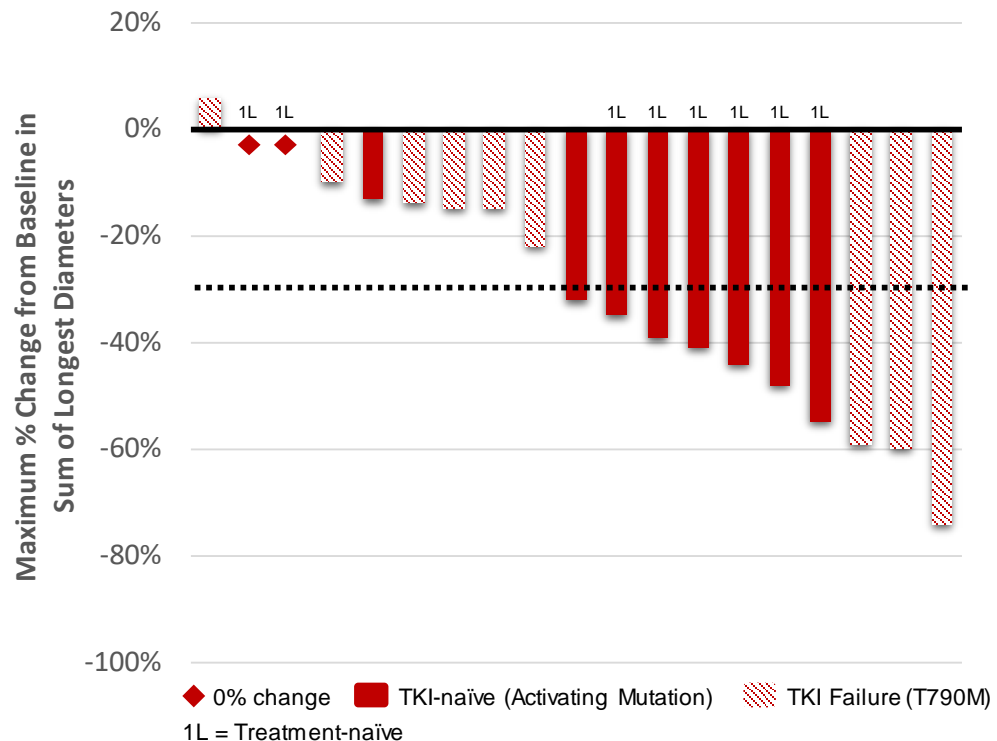

Interim response data as of November 2018.

CK-101: PLANNED PHASE 3 STUDY DESIGN

SIMILAR DESIGN AS USED BY TAGRISSO®



- Target enrollment: 12-15 mths
- Enrolling territories:
 - AsiaPac: China, Hong Kong, Taiwan, Thailand, New Zealand
 - Europe: Italy, Spain, Poland

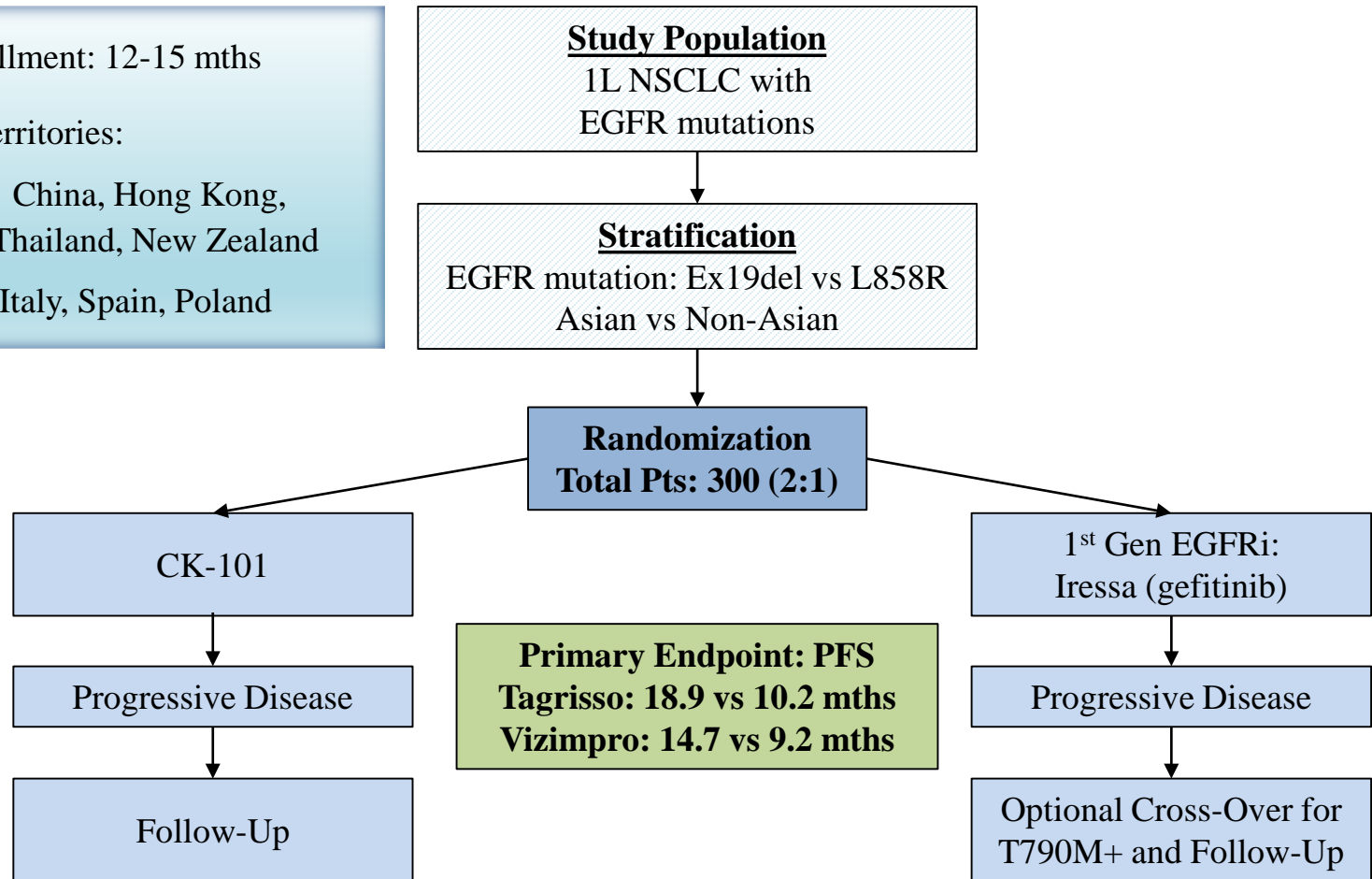

Targeting YE 2019 initiation: anticipate ~24 months to reach PFS endpoint

COSIBELIMAB: HIGH AFFINITY ANTI-PD-L1 DIFFERENTIATED THROUGH SUSTAINED >99% TUMOR TARGET OCCUPANCY WITH ADCC



Target Protein	Antibody	KD (M)	kon(1/Ms)	kdis(1/s)
huPDL1	CK-301	8.47E-10	7.20E+05	6.10E-04
cynoPDL1	CK-301	5.55E-10	1.14E+06	6.35E-04
huPDL1	atezolizumab*	2.02E-09	4.52E+05	9.11E-04
cynoPDL1	atezolizumab*	8.95E-09	6.10E+05	5.46E-03

Reversing T-Cell Inhibition

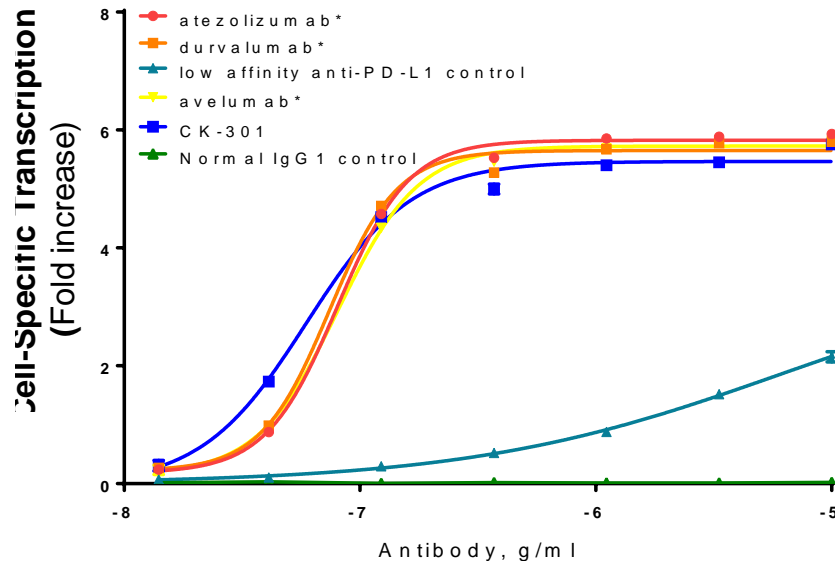

Induction of ADCC

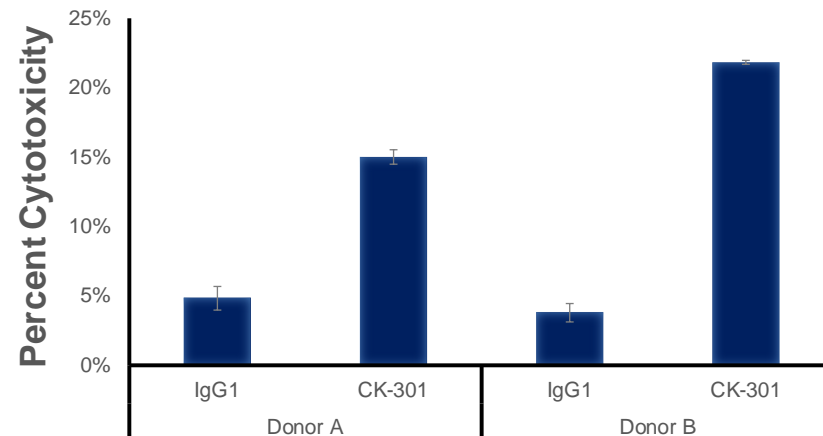

COSIBELIMAB: ONGOING PHASE 1 STUDY TRIAL DESIGN & STRATEGY

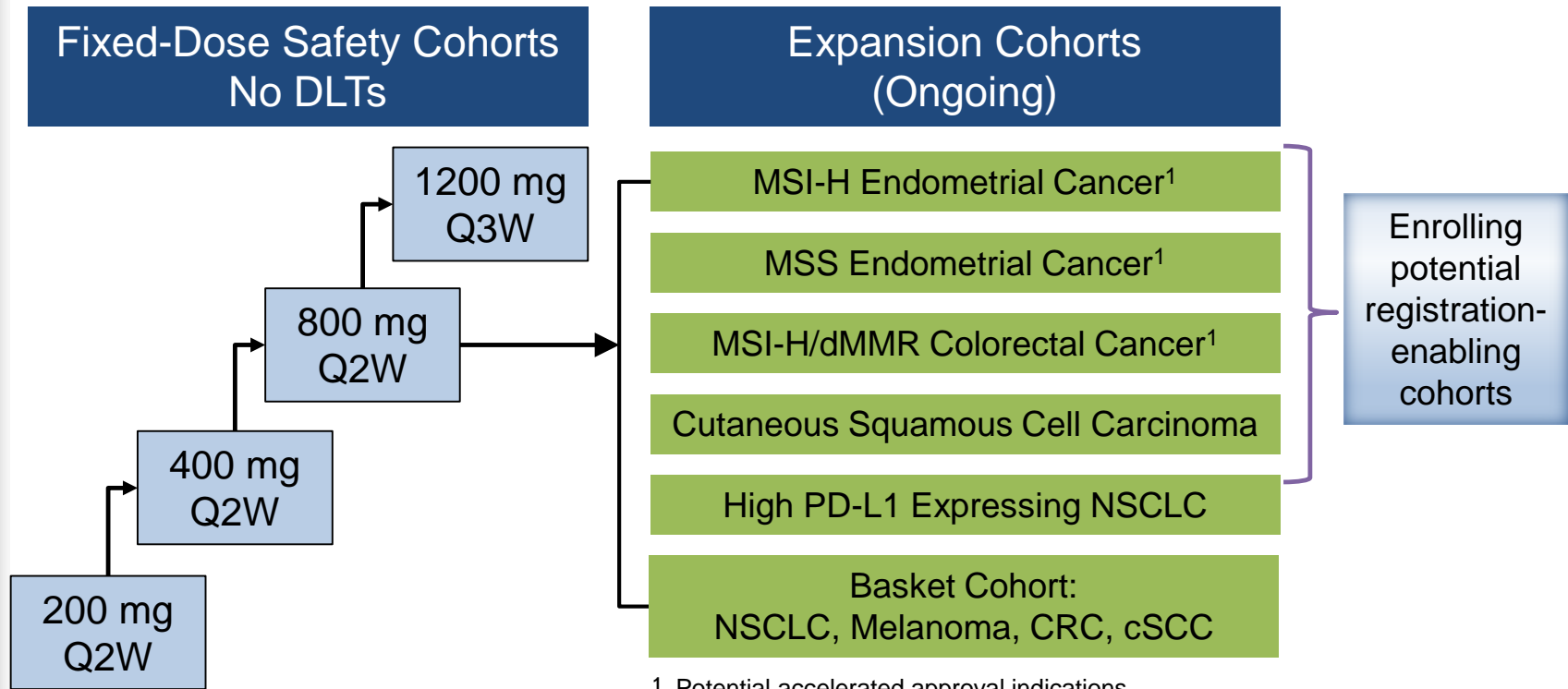

- Development strategy:
 - Pursue accelerated approval indications (endometrial/CRC)
 - Demonstrate activity in large established indications (NSCLC)
 - Explore combinations (internal & collaborations/partnerships)
- Commercial strategy: Market disrupting pricing

COSIBELIMAB: PHASE 1 INTERIM DATA

WELL-TOLERATED SAFETY PROFILE (N=65)



Treatment-Related AEs in ≥2 Patients

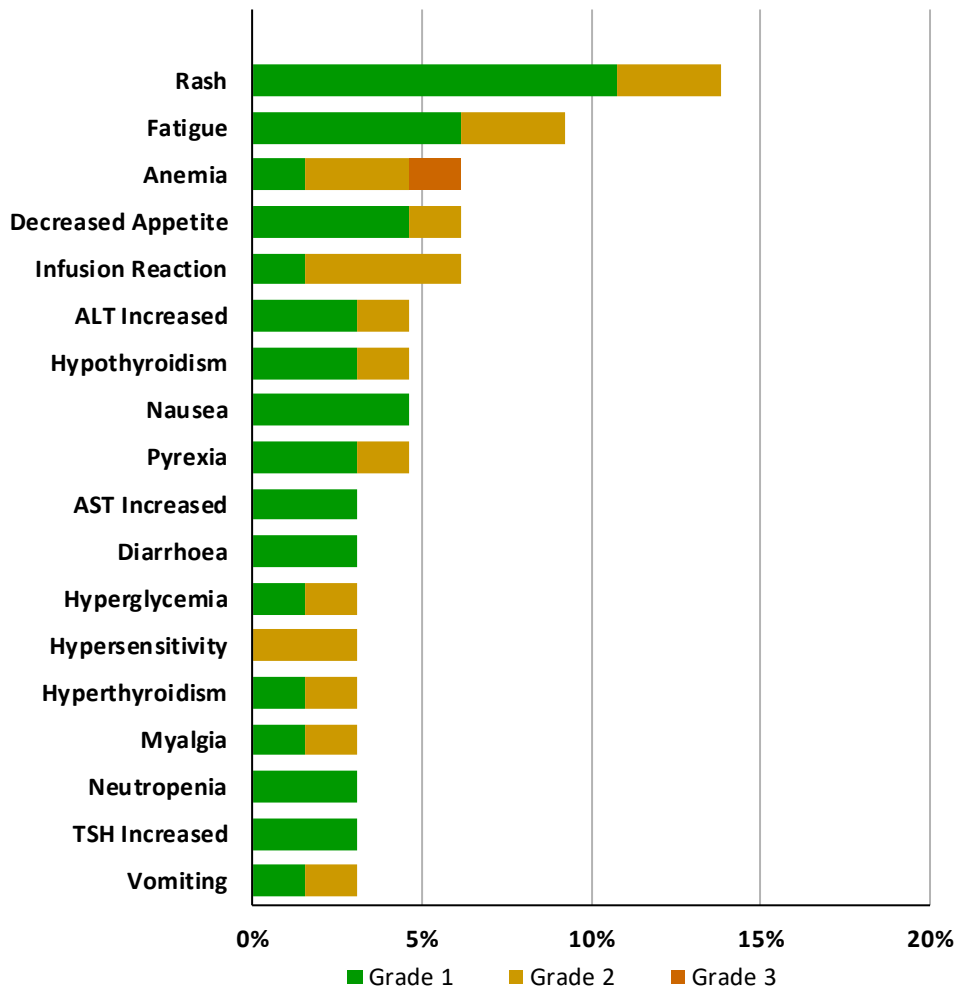

- Treatment-related AEs (TRAEs):
 - Any grade (32 pts, 49%)
 - Grade ≥3 (5 pts, 8%)
 - Substantially lower than the ≥20% G3+ TRAEs reported by best-in-class anti-PD-1s
 - No grade 4 or 5
 - Only 1 TRAE discontinuation
- 42 pts (65%) remain on treatment
 - Range: 1 – 17+ months

COSIBELIMAB: PHASE 1 INTERIM DATA

RESPONSE RATES BY RECIST 1.1



- ORRs of >40% observed in first-line non-small cell lung cancer and cutaneous squamous cell carcinoma; DCRs >80%

Responses by Tumor Type (N=36) ¹	Objective Response Rate (ORR) % (n)	Disease Control Rate (DCR) % (n)
All Tumor Types Combined	28% (10/36)	75% (27/36)
NSCLC (1 st Line with High [≥50%] PD-L1)	42% (5/12)	83% (10/12)
Cutaneous Squamous Cell Carcinoma	43% (3/7)	86% (6/7)
Melanoma	14% (1/7)	71% (5/7)
Other: Colorectal, Head/Neck Sq Cell, Hodgkin's Lymphoma, Mesothelioma, NSCLC (2 nd Line), Urothelial	10% (1/10)	60% (6/10)

¹ Interim data as of April 23, 2019. 17 additional patients pending first post-baseline response assessment at time of data cutoff.

COSIBELIMAB: PHASE 1 INTERIM DATA

ANTI-TUMOR ACTIVITY IN A VARIETY OF CANCERS



- 67% (24/36) of response evaluable patients experienced target lesion reductions vs baseline

Best Percent Change of Target Lesions by Tumor Type
Evaluable Population

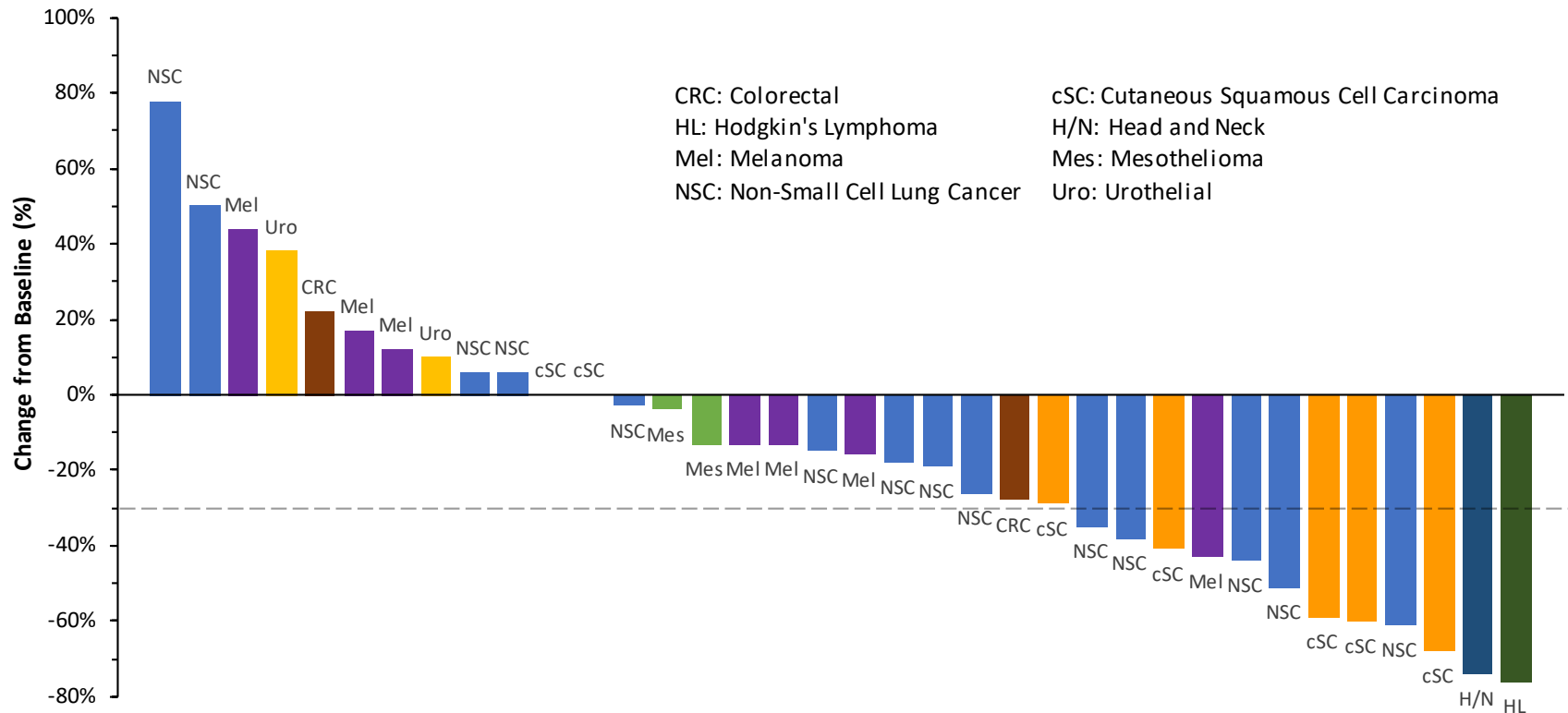



NOTABLE PD-(L)1 LICENSING DEALS

ENDPOINTS NEWS

Wednesday, October 25, 2017

Incyte grabs a new PD-1 checkpoint drug in \$900M deal with MacroGenics

- Incyte buys exclusive worldwide rights to Phase 1 anti-PD-1
- MacroGenics receives:
 - \$150MM upfront
 - \$420MM in development milestones
 - \$330MM in commercial milestones
 - Royalties: 15-24% of sales
 - Right to use the anti-PD-1 in combination with other pipeline products

FierceBiotech

Celgene bags Beigene PD-1 drug for \$263M up front

- Celgene buys ex-Asia solid tumor rights to early Phase 3 anti-PD-1
- Beigene receives:
 - \$413MM upfront (\$263MM cash / \$150MM stock)
 - \$1B in milestones
 - Royalties: up to ~25% of sales
 - Celgene's commercial operations in China, including three approved products



KEY TAKEAWAYS

- CK-101 (EGFRi)
 - Interim Ph 1 data presented at World Lung
 - Emerging safety differentiation vs Tagrisso
 - Add'l data and initiation of registration study expected at YE 2019
 - Large market opportunity dominated by one marketed drug
- Cosibelimab (anti-PD-L1)
 - Potentially differentiated vs marketed PD-(L)1s
 - Interim Ph 1 data shows clinical activity in multiple tumor types and well-tolerated safety profile
 - Enrolling cohorts intended to support potential BLA submissions
 - Exploring partnerships and collaborations

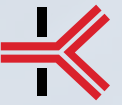

CHECKPOINT

THERAPEUTICS

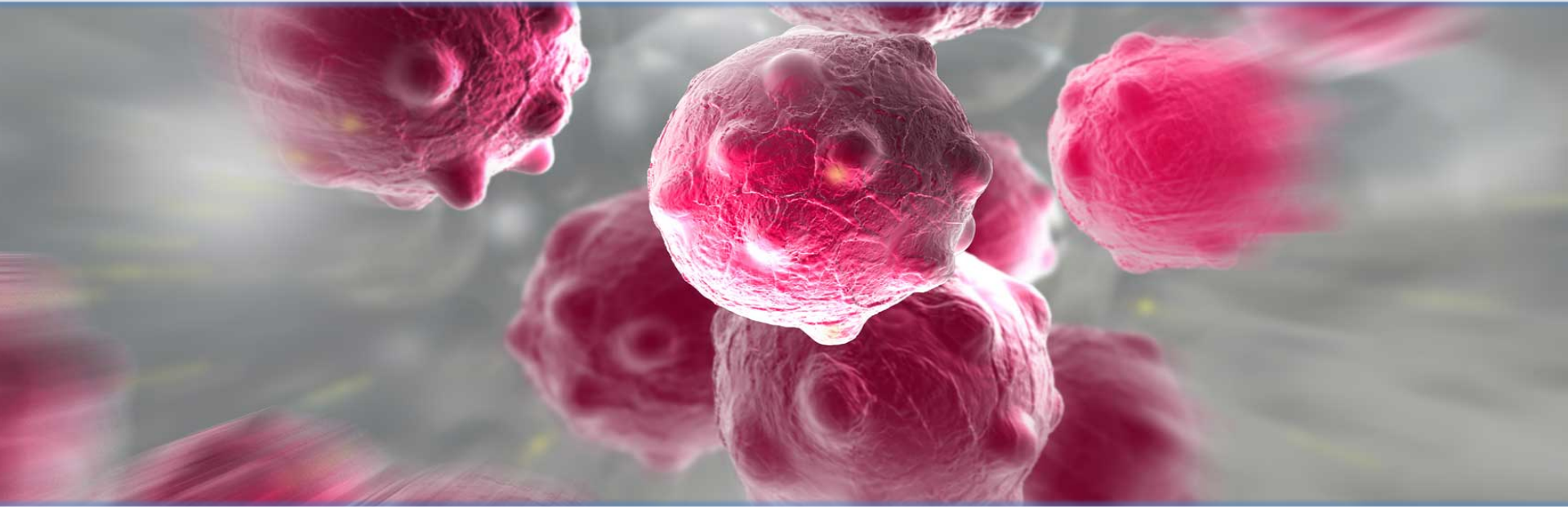

NASDAQ: CKPT
CORPORATE PRESENTATION

July 2019