

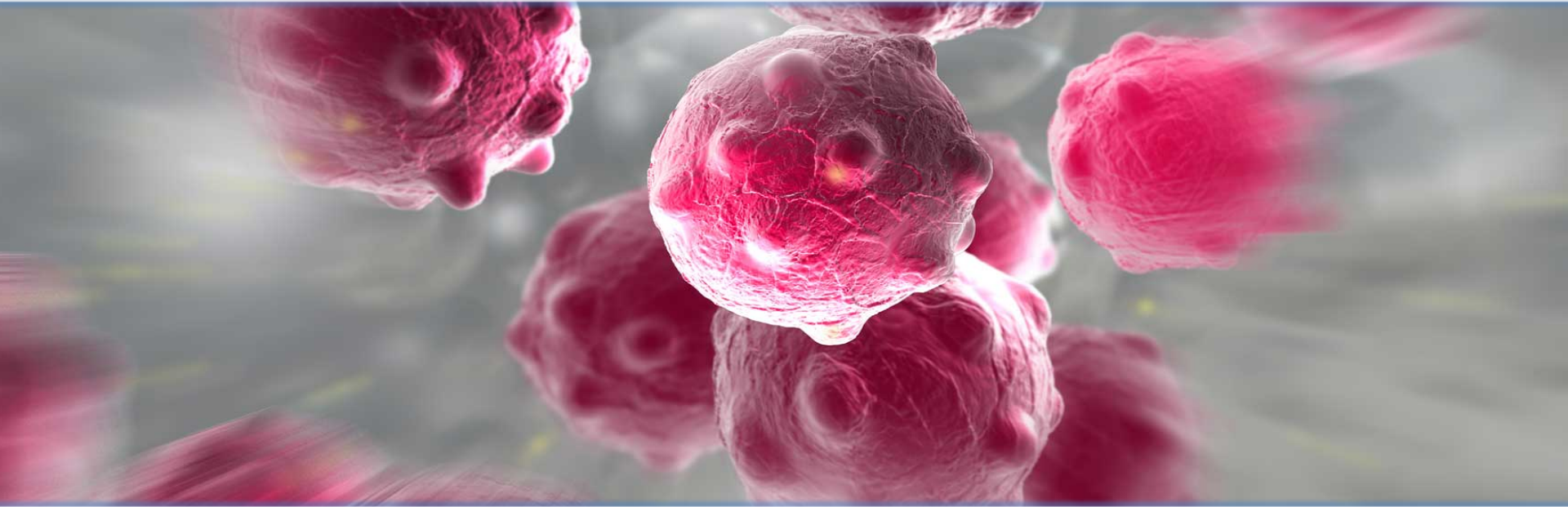

CHECKPOINT

THERAPEUTICS



NASDAQ: CKPT

CORPORATE PRESENTATION

March 2019

A microscopic view of several cells, likely cancer cells, against a purple and blue background. The cells are irregular in shape and have a textured, somewhat crystalline appearance. They are scattered across the upper half of the slide, with some appearing larger and more prominent than others. The background has a grainy, textured appearance, suggesting a high-magnification micrograph.

FORWARD LOOKING SAFE HARBOR STATEMENT

This presentation contains forward-looking statements within the meaning of the Private Securities Litigation Reform Act of 1995. These statements are often, but not always, made through the use of words or phrases such as “anticipates”, “expects”, “plans”, “believes”, “intends”, and similar words or phrases. Such statements involve risks and uncertainties that could cause Checkpoint Therapeutics’ actual results to differ materially from the anticipated results and expectations expressed in these forward-looking statements. These statements are only predictions based on current information and expectations and involve a number of risks and uncertainties. Actual events or results may differ materially from those projected in any such statements due to various factors, including the risks and uncertainties inherent in clinical trials, drug development, and commercialization. You are cautioned not to place undue reliance on these forward-looking statements, which speak only as of the date hereof. All forward-looking statements are qualified in their entirety by this cautionary statement and Checkpoint Therapeutics undertakes no obligation to update these statements, except as required by law.



ONCOLOGY PRODUCT PORTFOLIO: SOLID TUMOR FOCUS

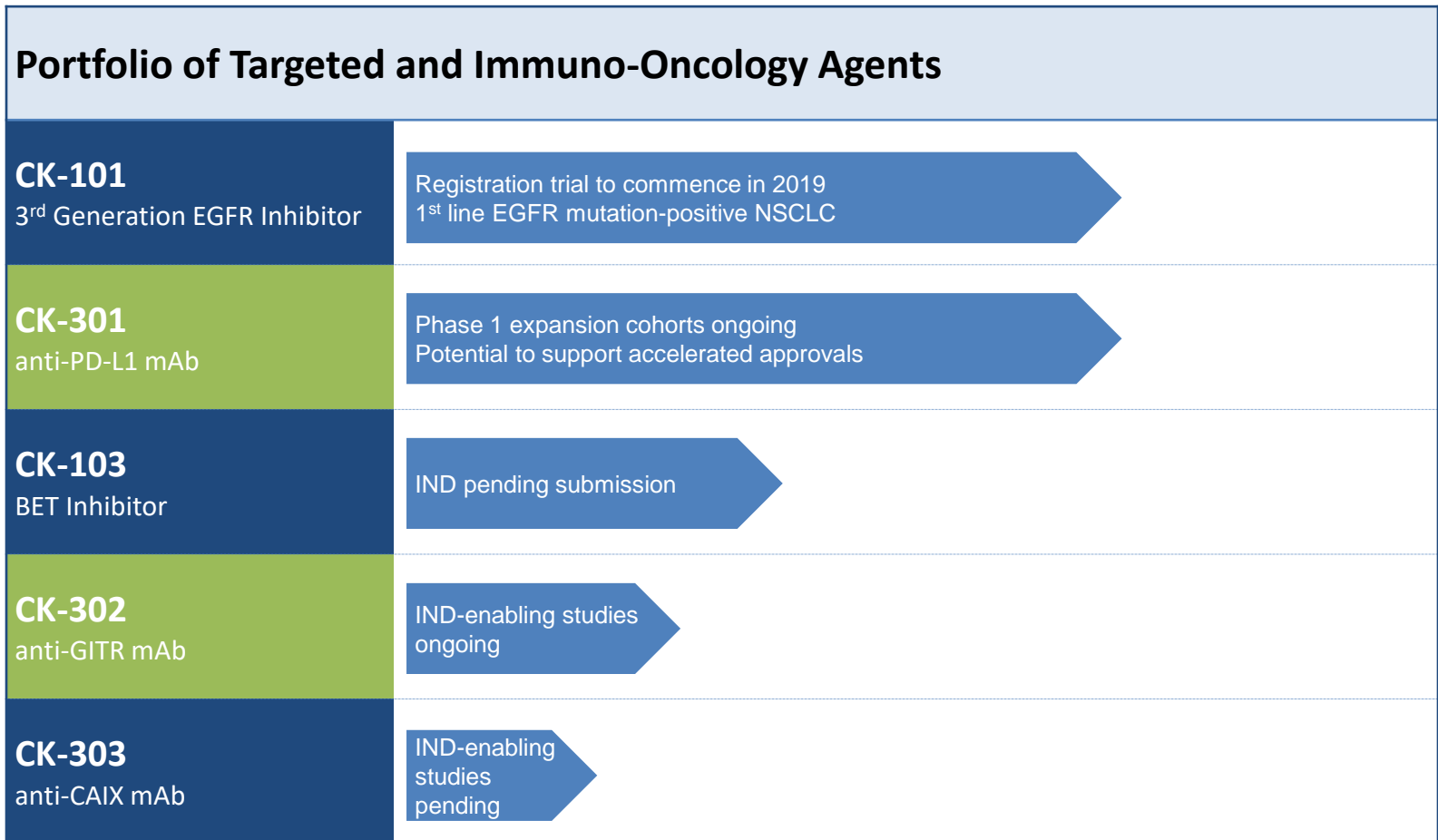

Targeted anti-cancer agents

Immuno-oncology agents



EGFR MUTATION-POSITIVE NSCLC: WELL-VALIDATED TARGET

- 1st and 2nd generation EGFR inhibitors lead to acquired resistance to therapy, mainly due to T790M resistance mutation
- 3rd generation EGFR inhibitors target EGFR activating mutations and T790M resistance mutation leading to longer responses
 - Tagrisso[®] (osimertinib) is only marketed 3rd gen inhibitor with a projected market oppty >\$6 billion annually
 - Warnings and precautions: QTc prolongation (4.5%), interstitial lung disease (3.9%), cardiomyopathy (2.6%)
 - Ph 3 (FLAURA) study AEs: diarrhea (58%), rash (58%), dry skin (36%), nail toxicity (35%), stomatitis (29%)
 - 13% of pts permanently discontinued due to AEs



CK-101: 3RD GENERATION, IRREVERSIBLE MUTANT-SELECTIVE EGFR INHIBITOR

- In mice, CK-101 showed strong activity against EGFR (T790M) mutant NSCLC with increasing dose.

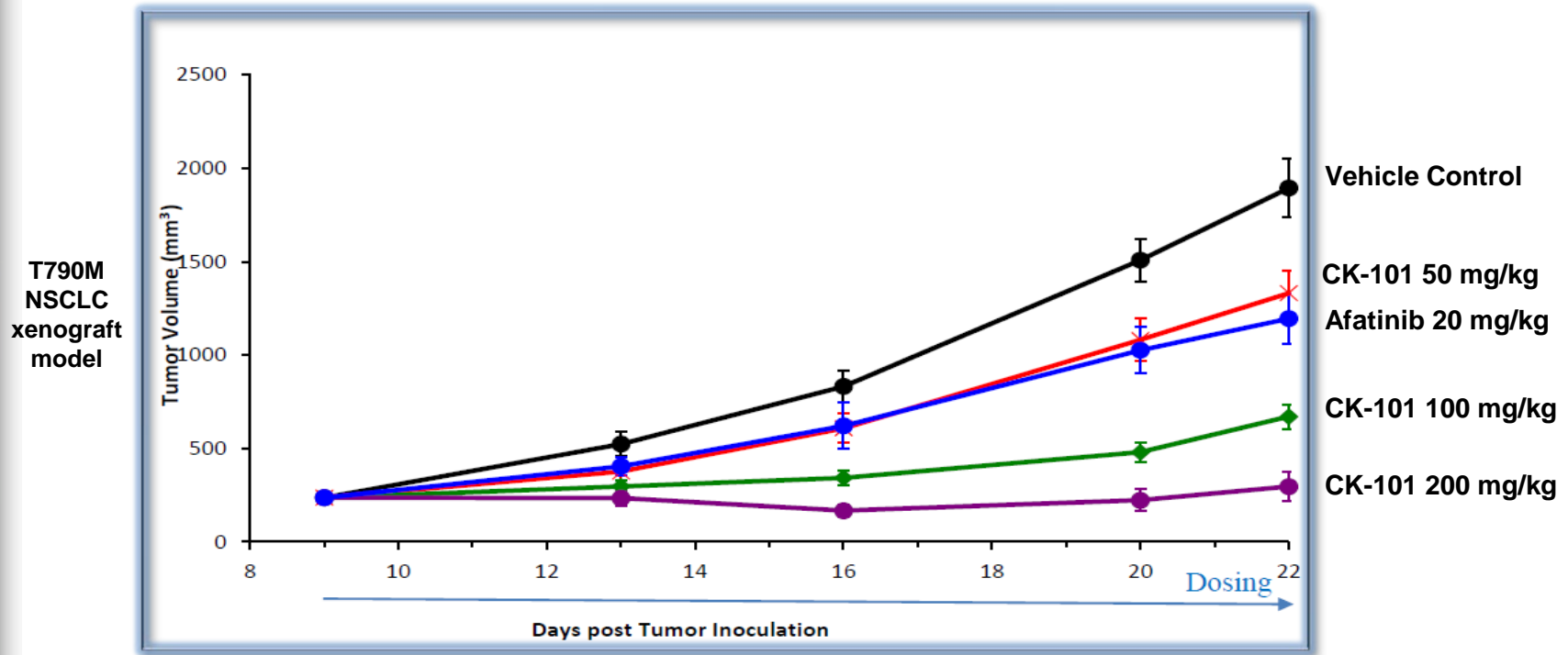



CK-101: 3RD GENERATION, IRREVERSIBLE MUTANT-SELECTIVE EGFR INHIBITOR

- In mice, CK-101 showed no activity against wild-type (normal) EGFR with increasing dose.

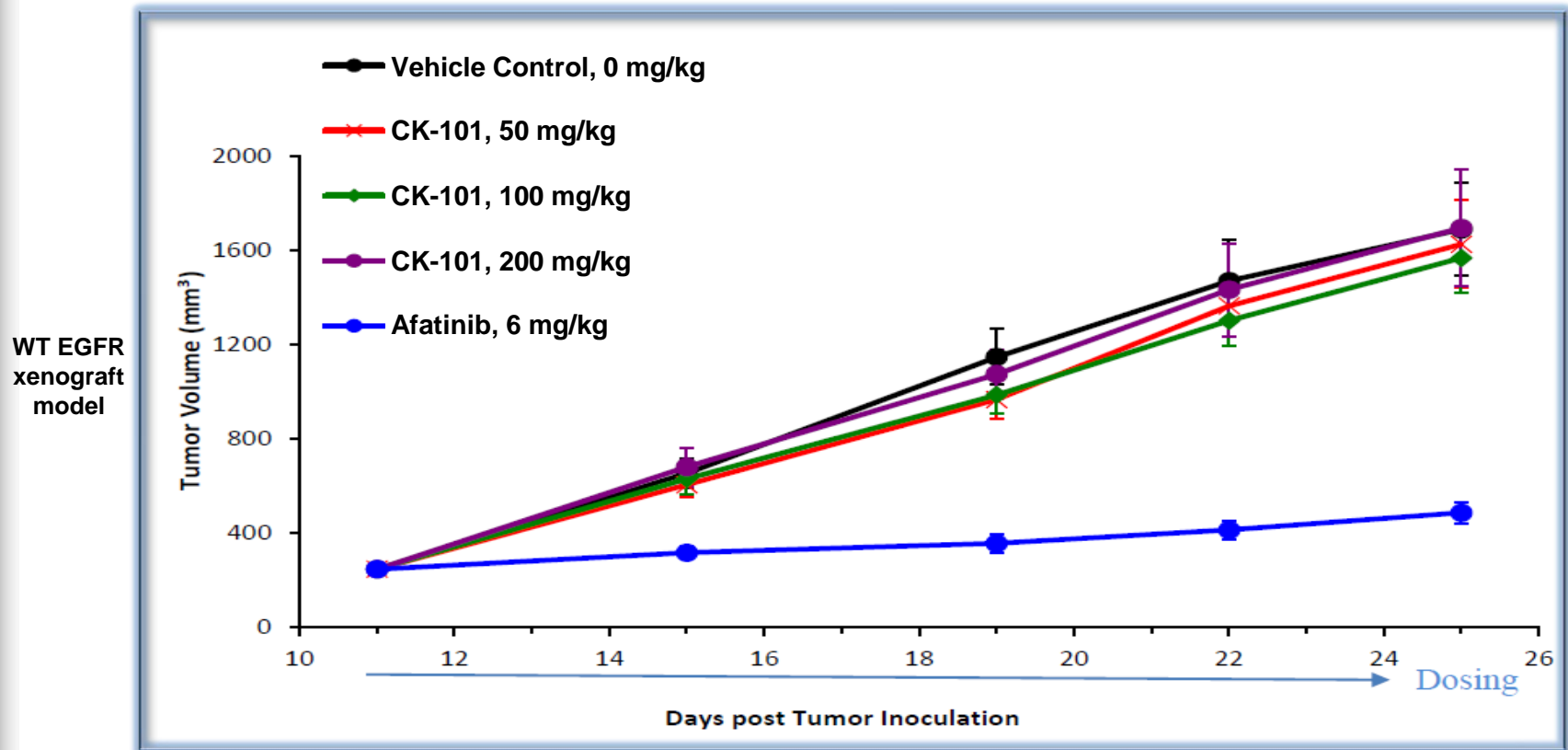

CK-101: ONGOING PHASE 1 CLINICAL STUDY



Dose Escalation Cohorts
All Solid Tumors
(N=18)

Expansion Cohort: 400 mg bid
NSCLC Target Population
(N=19)

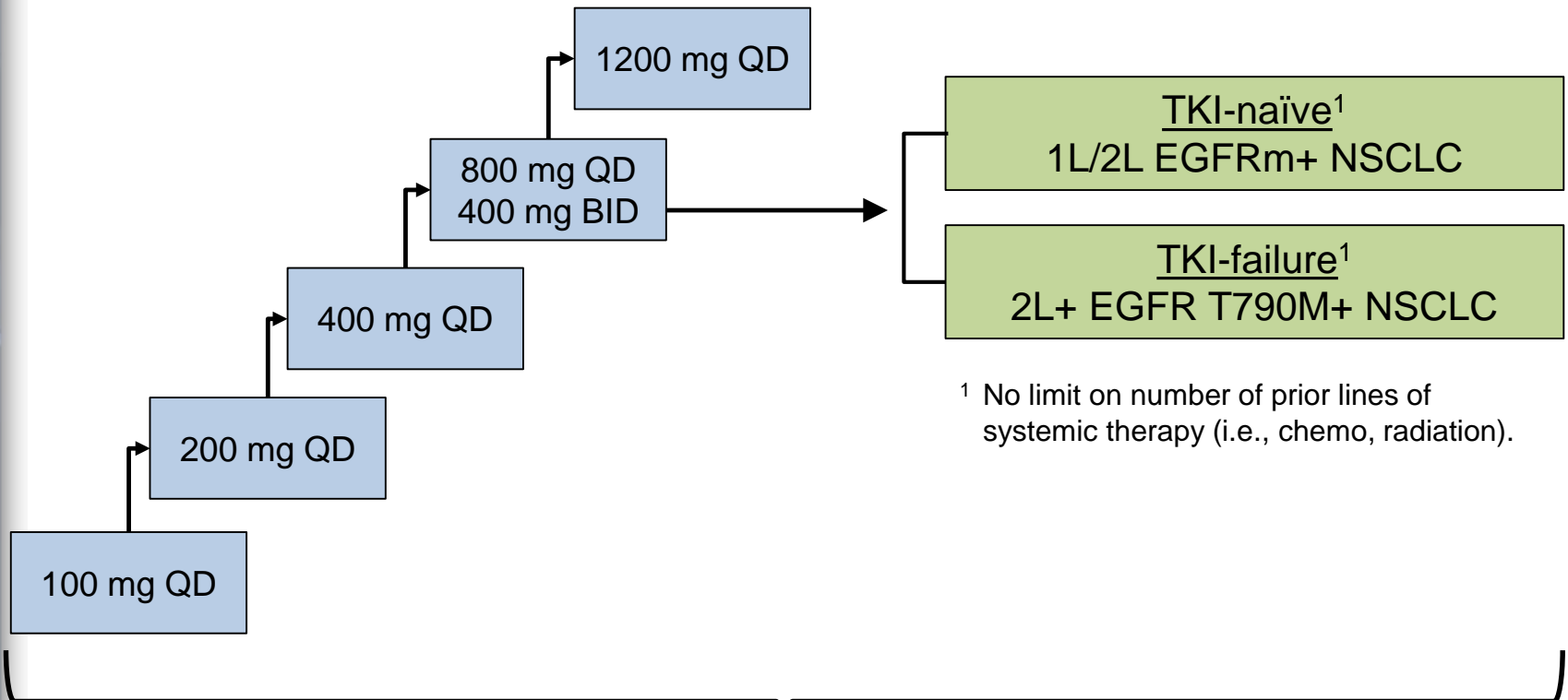

¹ No limit on number of prior lines of systemic therapy (i.e., chemo, radiation).

Oral Presentation World Conference on Lung Cancer (WCLC)
Sept 2018

CK-101 PHASE 1 INTERIM DATA

SAFETY: EMERGING DIFFERENTIATION



- CK-101 was well-tolerated
 - Most adverse events were Grade 1-2
 - No DLTs or treatment-related SAEs
 - MTD has not been defined
- **No events of:**
 - Interstitial lung disease (ILD)
 - Pneumonitis
 - QTc prolongation
 - Cardiomyopathy
 - Nail toxicities
 - Stomatitis
 - Hyperglycemia

Most Common ($\geq 10\%$) Treatment-Related Adverse Events, n (%)	All Patients Treated (N=37)		
	All Grades	Grade 3	Grade 4
Nausea	6 (16%)	-	-
Diarrhea	5 (14%)	1 (3%)	-
Lacrimation increased	5 (14%)	-	-
Vomiting	4 (11%)	-	-

CK-101 PHASE 1 INTERIM DATA

EFFICACY



- Confirmed ORR: 53% (10/19)
 - 75% (6/8) treatment-naïve pts achieved PR
 - 100% (19/19) DCR
 - 84% (16/19) pts had target lesion reductions versus baseline
- 60% (3/5) pts with brain mets at baseline achieved PR with intracranial reductions

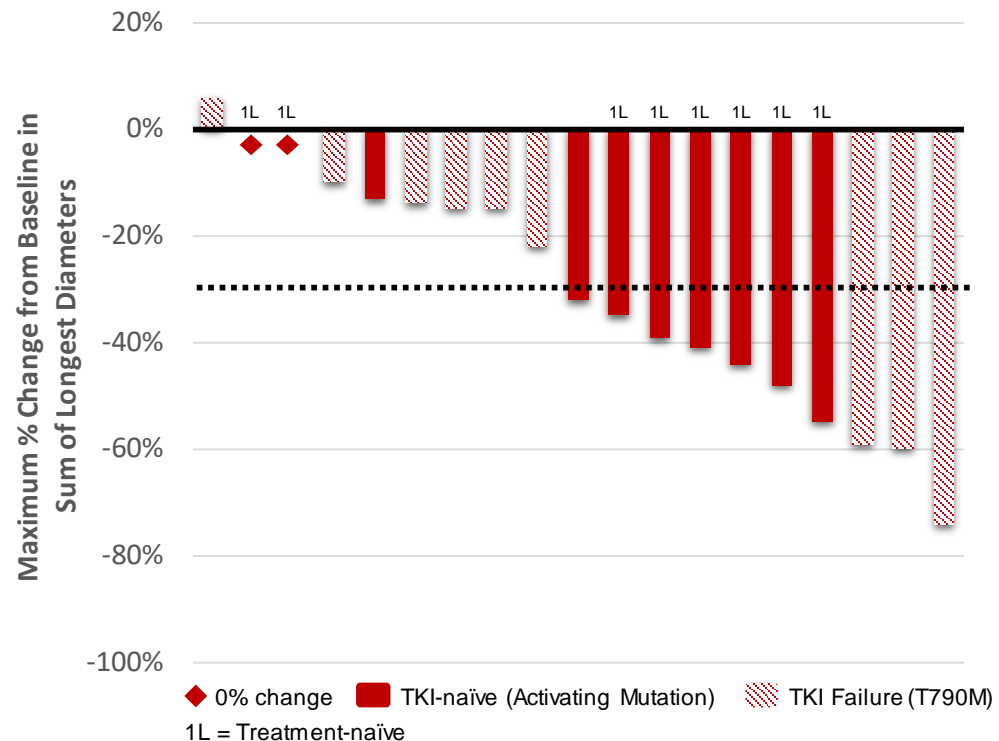

CK-101: PLANNED PHASE 3 STUDY DESIGN

SIMILAR DESIGN AS USED BY TAGRISSO®

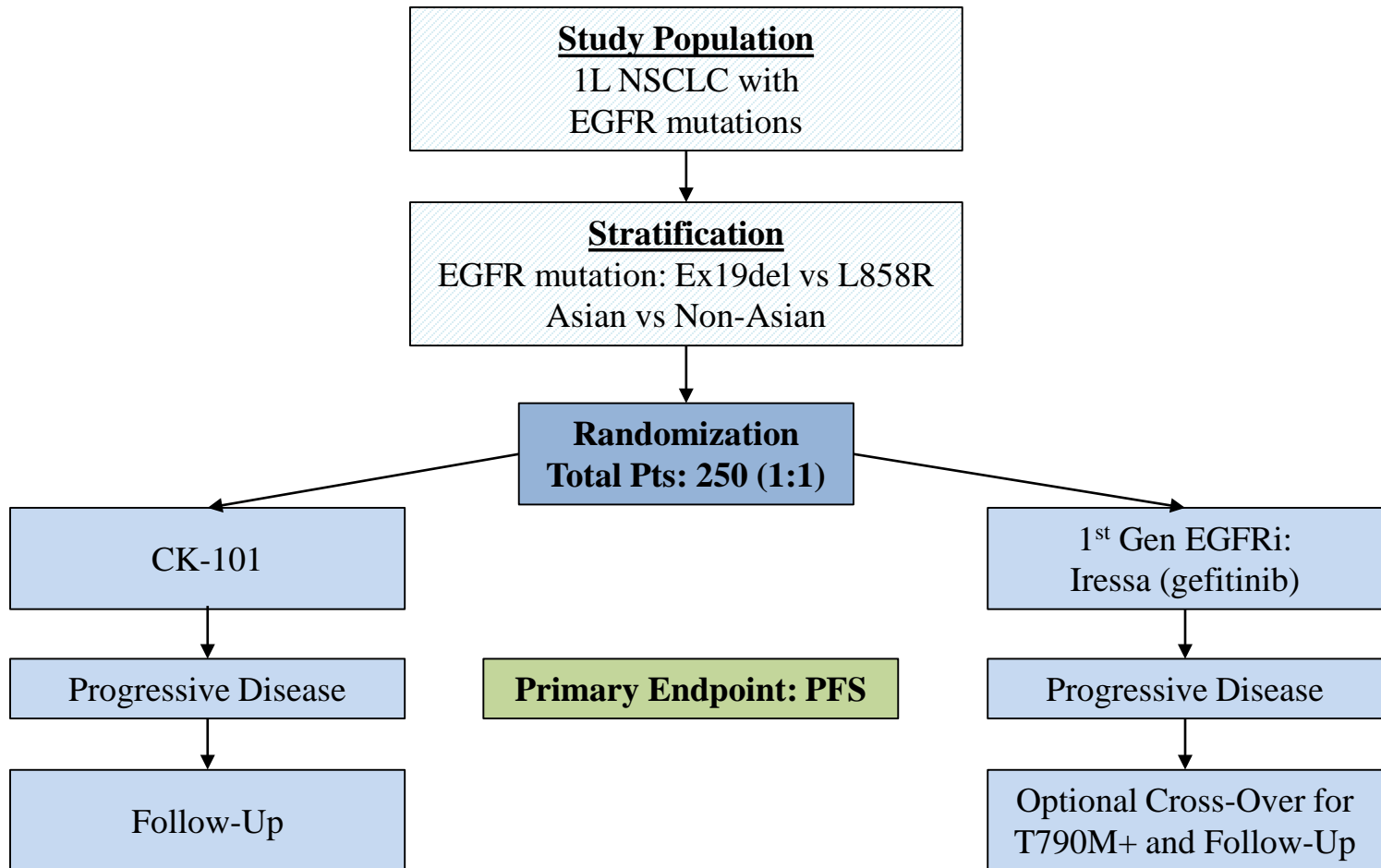

2019 initiation: ~24 months to enroll and reach PFS endpoint



CK-301: ANTI-PD-L1

- Fully human IgG1 monoclonal antibody that binds PD-L1
- Licensed from Dana-Farber Cancer Institute
 - Native Fc region could induce antibody-dependent cell-mediated cytotoxicity (ADCC) for additional anti-tumor activity
 - Binding affinity optimized by Adimab to compete with best-in-class approved antibodies
- Development strategy:
 - Pursue accelerated approval indications (endometrial/CRC)
 - Demonstrate activity in established indications (NSCLC)
- Commercial contract manufacturer in place



CK-301: HIGH AFFINITY BINDING TO PD-L1

Target Protein	Antibody	KD (M)	kon(1/Ms)	kdis(1/s)
huPDL1	CK-301	8.47E-10	7.20E+05	6.10E-04
cynoPDL1	CK-301	5.55E-10	1.14E+06	6.35E-04
huPDL1	atezolizumab*	2.02E-09	4.52E+05	9.11E-04
cynoPDL1	atezolizumab*	8.95E-09	6.10E+05	5.46E-03

ELISA on PD-L1 coated plates

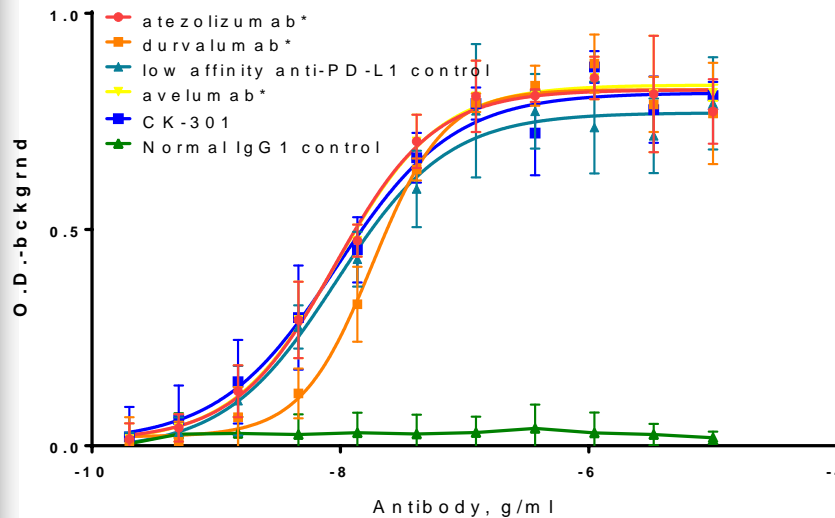

FACS with PD-L1+ cells

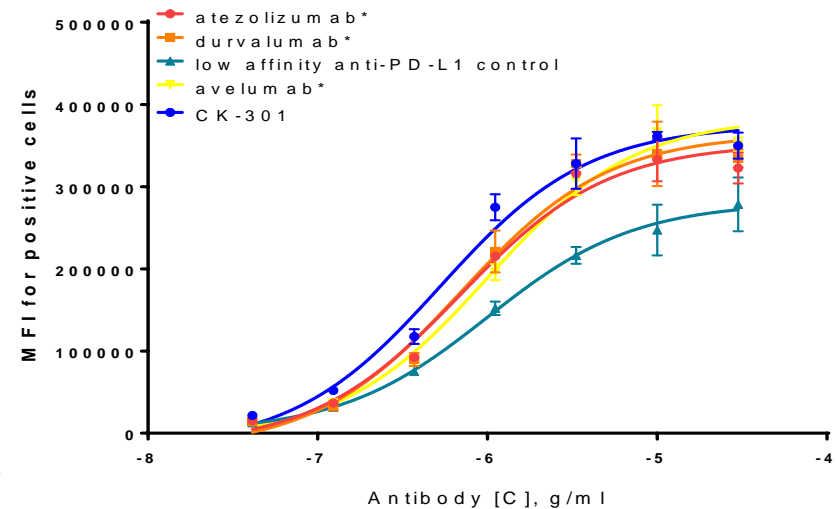



CK-301: PHASE 1 CLINICAL STUDY IN ADVANCED CANCERS (I-O NAÏVE)

- Interim safety and efficacy data expected in 1H 2019

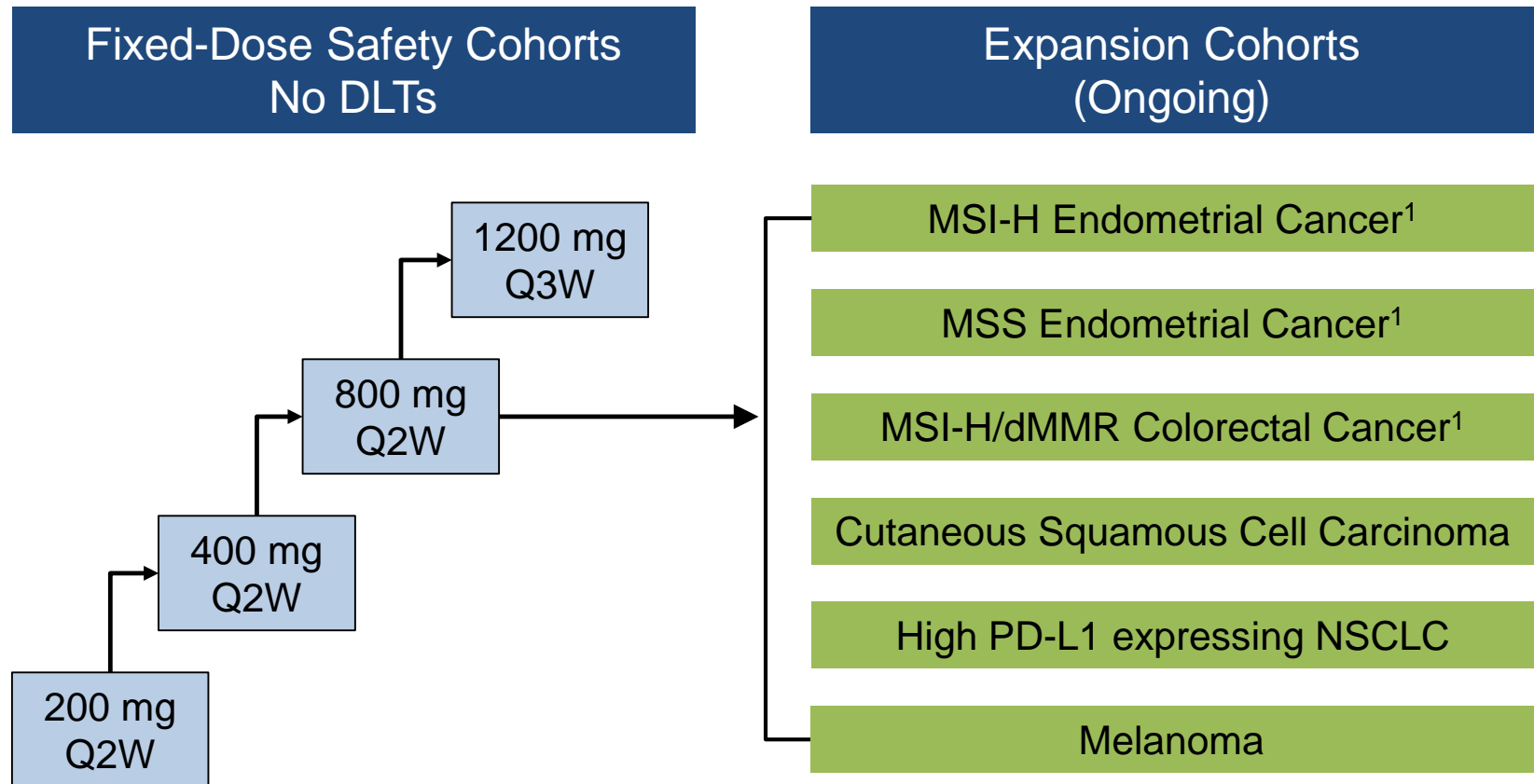

¹ Potential accelerated approval indications. MSI-H: microsatellite instability-high. dMMR: DNA mismatch repair deficient.



RECENT PD-(L)1 LICENSING DEALS

ENDPOINTS NEWS

Wednesday, October 25, 2017

Incyte grabs a new PD-1 checkpoint drug in \$900M deal with MacroGenics

- Incyte buys exclusive worldwide rights to Phase 1 anti-PD-1
- MacroGenics receives:
 - \$150MM upfront
 - \$420MM in development milestones
 - \$330MM in commercial milestones
 - Royalties: 15-24% of sales
 - Right to use the anti-PD-1 in combination with other pipeline products

FierceBiotech

Celgene bags Beigene PD-1 drug for \$263M up front

- Celgene buys ex-Asia solid tumor rights to early Phase 3 anti-PD-1
- Beigene receives:
 - \$413MM upfront (\$263MM cash / \$150MM stock)
 - \$1B in milestones
 - Royalties: up to ~25% of sales
 - Celgene's commercial operations in China, including three approved products



KEY TAKEAWAYS

- Lead EGFR inhibitor and anti-PD-L1 programs enrolling expansion cohorts with clinical activity observed
- CK-101 (EGFRi): interim data presented at World Lung; add'l data and commencement of registration study in 2019
- CK-301 (anti-PD-L1): interim data in 1H 2019; pursuing rapid accelerated approvals in indications with high unmet need
- Exploring potential proprietary combinations with PD-L1 backbone (e.g., PD-L1 combo w EGFRi)